

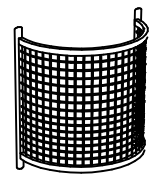

TYPE	HAGS.NO
	610922 61092213
0,33x0,71x0,76m	
	616150
0,36x0,67m	



<b>A</b>		15/7x3(6x) (261819)
	TKFT 6x38(6x) (311100)	
<b>B</b>		COVER 8 (261808)
	SRB 9x18 (326017)	
	MGS 8x20 (302156)	CAP 8 (261807)
<b>C</b>		MVBF 6x35 (304554)
	SRB 7x14 (326016)	COVER 6 (261801)
	DIST 6 (261802)	CAP 6 (261800)
	N 6 (324101)	
<b>D</b>		MVBF 8x40 (304604)
	SRB 9x18 (326017)	COVER 8 (261808)
	DIST 8 (261809)	CAP 8 (261806)
	N 8 (324102)	

**HAGS** ANEBY, SWEDEN  
+46(0)380-47300  
www.hags.com

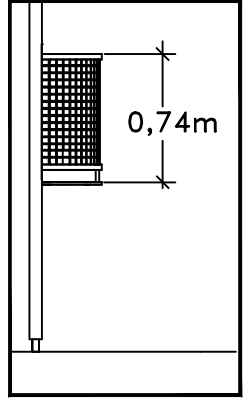
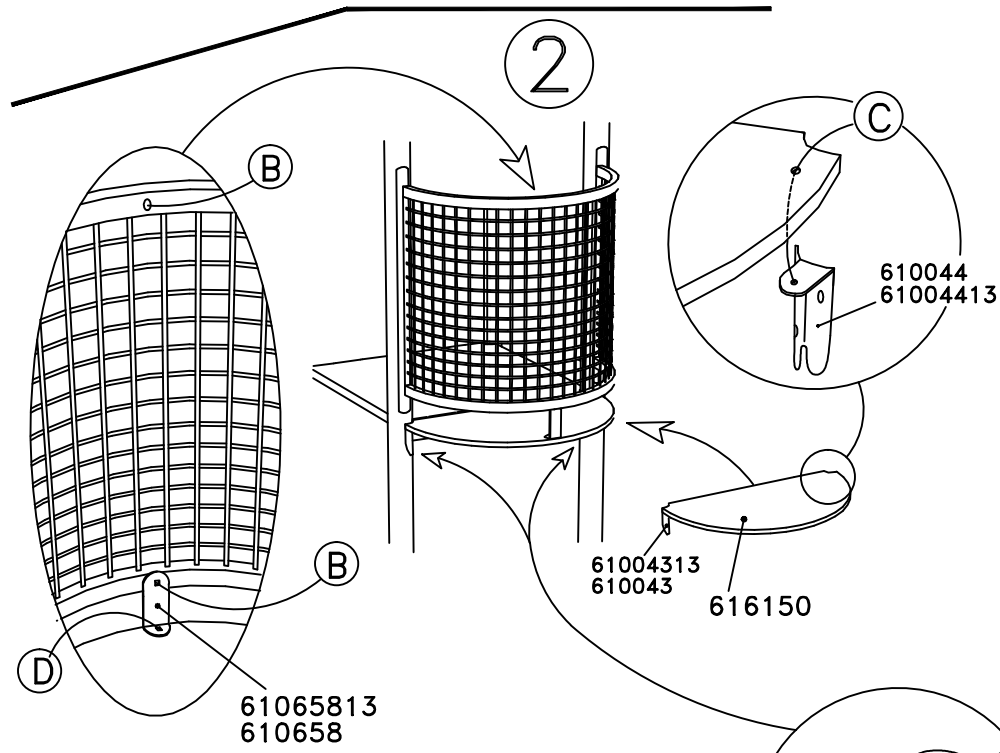
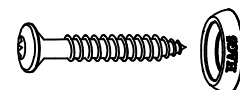
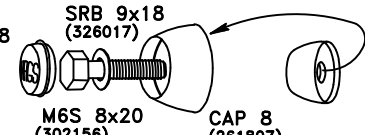
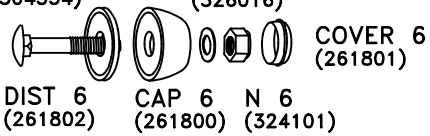
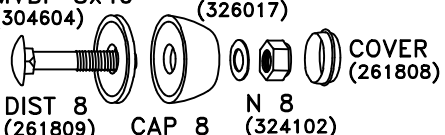
6922 13

ACJ OG 2013-03-15 1